

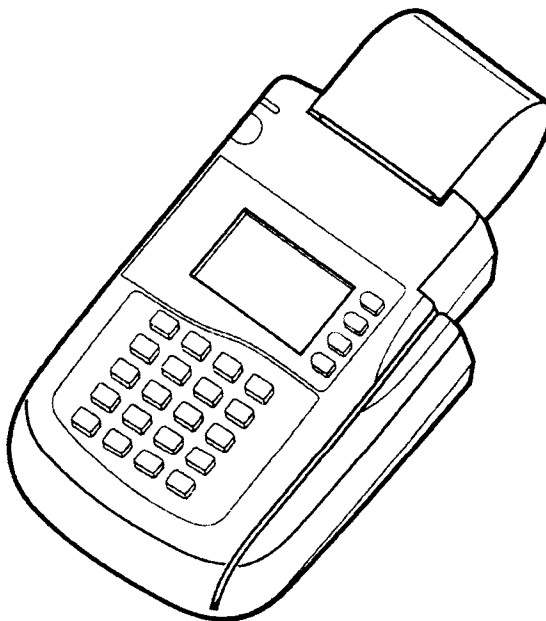

OMNI 3200

Installation Guide



FCC Part 68

This equipment complies with Part 68 of the FCC Rules. Located on the bottom panel of this terminal is a label that contains, among other information, the FCC registration number and ringer equivalence number (REN) for this unit. If requested, this information may be provided to the telephone company. An FCC-compliant cord and modular plug is provided with this equipment. This equipment is designed to be connected to the telephone network or premises wiring using a compatible modular jack which is FCC Part 68 compliant.

The REN is used to determine the quantity of devices that may be connected to the telephone line. Excessive RENs on the telephone line may result in the device not ringing in response to an incoming call. In most, but not all areas, the sum of the RENs should not exceed five (5.0). To be certain of the number of devices that may be connected to the line, as determined by the total RENs, contact the telephone company to determine the maximum REN for the calling area.

If this terminal causes harm to the telephone network, the telephone company will notify you in advance that temporary discontinuance of service may be required. However, if advance notice is not practical, the telephone company will notify the customer as soon as possible. Also, you will be advised of your right to file a complaint with the FCC if you believe it is necessary.

The telephone company may make changes in its facilities, equipment, operations, or procedures that could affect the operation of this equipment. If this happens, the telephone company will provide advance notice in order for you to make the necessary modifications in order to maintain uninterrupted service.

No repairs may be performed by the user. If trouble is experienced with this equipment, please call the VeriFone Customer Support Hot Line (800-654-1674 inside the U.S. or 714-979-1870 outside the U.S.), or contact your VeriFone representative or service provider for repair and/or warranty information. If the trouble is causing harm to the telephone network, the telephone company may request that you remove this equipment from the network until the problem is solved.

This terminal cannot be used on public coin service provided by the telephone company. Connection to Party Line Service is subject to state tariffs. (Contact the state public utility commission, public service commission, or corporation commission for information.)

It is recommended that the customer install an AC surge arrester in the AC outlet to which this device is connected. This is to avoid damage to the equipment caused by local lightning strikes and other electrical surges.

FCC Compliance

Manufacturer: VeriFone, Inc.
Model: OMNI 3200
Ringer equivalence: 0.3 A
USOC modular telephone jack: RJ11

Lithium Battery Caution

The Random Access Memory (RAM) in the OMNI 3200 terminal is protected by a lithium battery. Do not, under any circumstances, attempt to replace the lithium battery. Failure to comply may invalidate our warranty.

Copyright © 1998 VeriFone, Incorporated. All rights reserved.

No part of this publication may be copied, distributed, stored in a retrieval system, translated into any human or computer language, transmitted, in any form or by any means, without the prior written consent of VeriFone, Incorporated.

VeriFone and OMNI are registered trademarks of VeriFone, Incorporated. All other brand names and trademarks appearing in this guide are the property of their respective holders.



Table of Contents

Introduction	1
Installing the OMNI 3200	2
Step 1: Select a Location for the Terminal	2
Step 2: Unpack the Shipping Carton	3
Step 3: Examine Terminal Features	4
Step 4: Connect the Terminal to a Telephone Line	8
Step 5: Connect Optional Device(s)	11
Step 6: Connect the Terminal Power Pack	15
Step 7: Install a Paper Roll in the Printer	16
Maintaining the OMNI 3200	18
Cleaning the Terminal	18
Cleaning the Printer	18
Returning a Terminal for Service	19
Troubleshooting	21
Specifications	25
Accessories	26
How to Order	26

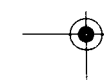
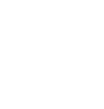
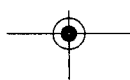
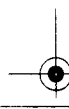
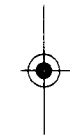
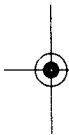

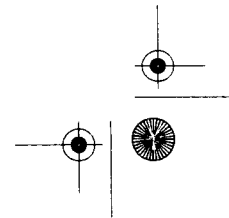
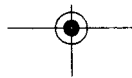
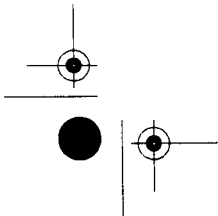
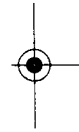
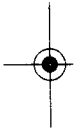
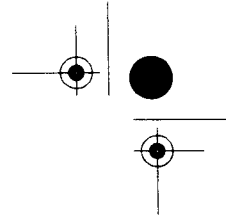



OMNI 3200 Installation Guide



Introduction

The OMNI 3200 is an electronic transaction terminal capable of gathering and transferring information at high speed. It is a fully integrated countertop solution which offers versatility, reliability, and low cost of ownership (see Figure 1).

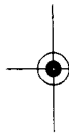
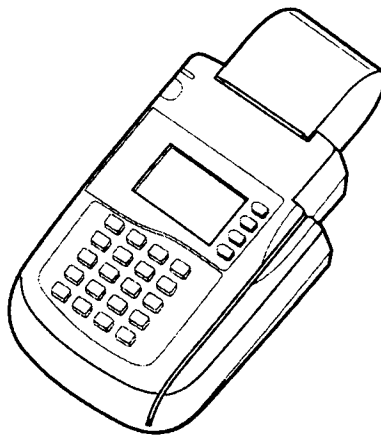
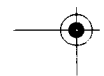
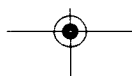

Figure 1 OMNI 3200 Terminal

The OMNI 3200 supports many different kinds of business applications, including:

- Electronic Point-Of-Sale (POS) payment transfer and authorization
- Credit, debit, and ATM card transactions
- Check processing
- Electronic benefits transfer (EBT)
- Inventory and process tracking





OMNI 3200 Installation Guide

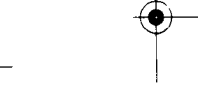

Installing the OMNI 3200

Step 1: Select a Location for the Terminal

Select a location for the terminal that is convenient for both cashier and cardholder, and which offers adequate ventilation and protection.



Caution: The OMNI 3200 terminal is designed for indoor use only.

Place the OMNI 3200 on a flat surface such as a table or countertop. Avoid areas with:

- Excessive heat or dust
- Oil or moisture
- Devices that cause excessive voltage fluctuations or electrical noise, such as air conditioners, fans, electric motors, neon signs, or high-frequency security devices
- Direct sunlight or objects that radiate heat

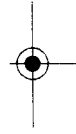
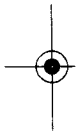

The terminal should also be conveniently located in relation to telephone line and power connections. The two power pack cables are each about 6 feet (1.8 meters) long and the telephone line cord is about 7 feet (2.1 meters) long. The telephone line connection for your OMNI 3200 requires a telephone base unit or a modular telephone company wall jack.



Warning: Do not use this product near water, including a bathtub, wash bowl, kitchen sink, or laundry tub. Do not use in a wet basement or near a swimming pool. Avoid using a telephone (other than a cordless type) during an electrical storm.

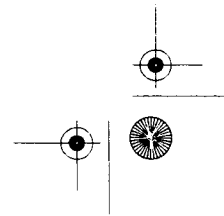
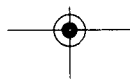
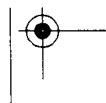
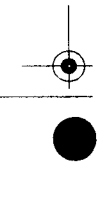

OMNI 3200 Installation Guide

Step 2: Unpack the Shipping Carton



Note: Carefully inspect the shipping carton and its contents for shipping damage (see Figure 2). If the terminal, or any other component, appears damaged, file a claim immediately with the shipping company and notify VeriFone. Do not use a damaged terminal.

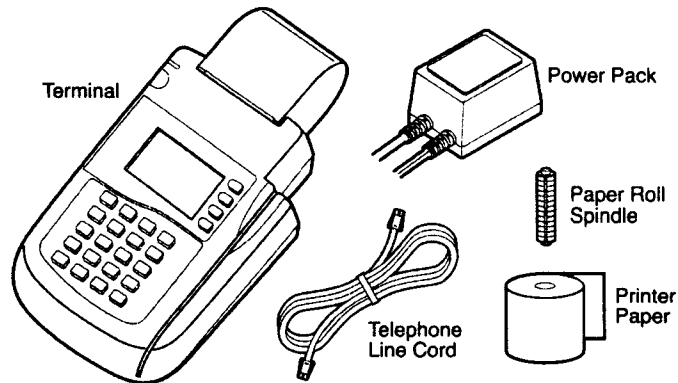

Figure 2 OMNI 3200 Product Components

Follow these steps to unpack the carton:

1. With the shipping carton right side up, open the top and remove all items from the carton:
 - OMNI 3200 terminal
 - Power pack
 - Telephone line cord
 - Roll of thermal printer paper
 - Plastic paper roll spindle

OMNI 3200 Installation Guide



Note: The roll of thermal printer paper and the paper roll spindle may have been installed in the OMNI 3200 terminal prior to shipment.

2. Remove any protective plastic wrapping from the terminal or other components and place them on a table or countertop.
3. Save the shipping carton and packing material for repacking or moving the terminal in the future.

Step 3: Examine Terminal Features

Before you continue the installation, please take a moment to note the important features of the OMNI 3200 (see Figure 3).

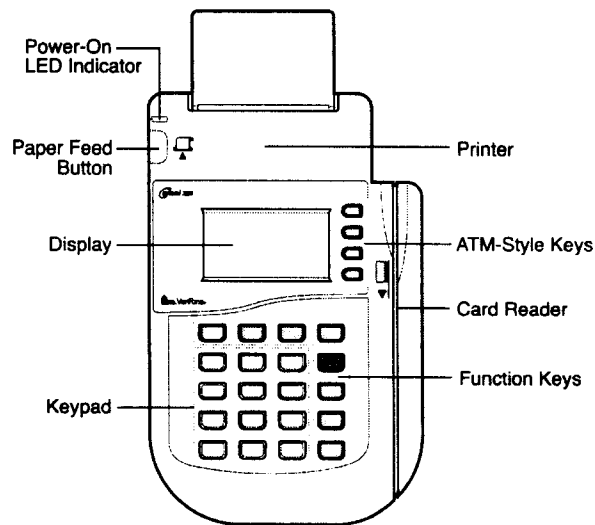

Figure 3 Features of the OMNI 3200 Terminal

OMNI 3200 Installation Guide

General Features

Viewing the top surface of the OMNI 3200 terminal, you will notice the following features:

- In the center of the terminal, a display screen with a non-removable, clear protective cover.
- 24 keys, arranged in groups (see Figure 4):
 - A 12-key, telephone-style keypad
 - Eight function keys (four to the right of the 12-key keypad, and four above the keypad)
 - Four ATM-style keys to the right of the display

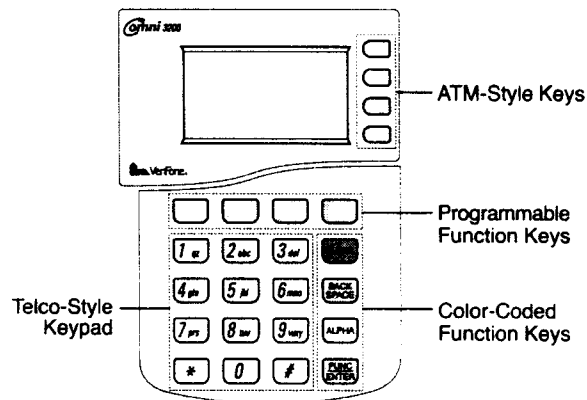

Figure 4 OMNI 3200 Keypad and Function Keys

- A magnetic stripe card reader, built in to the right side of the terminal. A graphical icon, shown to the right, indicates the proper card position and swipe direction (see Figure 5).





OMNI 3200 Installation Guide

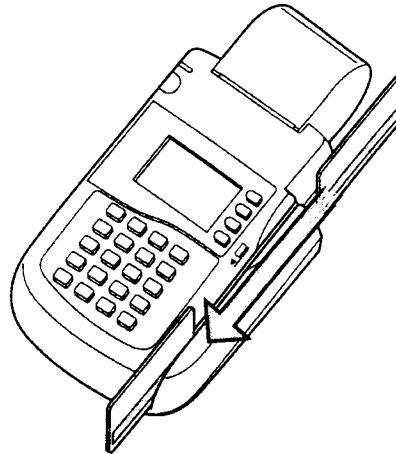

Figure 5 Using the OMNI 3200 Card Reader

- A thermal printer, fully integrated into the upper part of the terminal. In the top left corner of the terminal is a small LED power-on and “no paper” indicator, and a paper feed button. A graphical icon, shown to the right, indicates the location and function of this button.



Connection Ports on the Back Panel

If you turn the terminal around and view it from the back, you will notice five jacks, or ports, that are used to connect the OMNI 3200 to a telephone line, to optional external devices, and to a power source (see Figure 6). Four ports are located below the paper roll cradle and one is located to the right of the cradle. These ports are described in left-to-right order below.

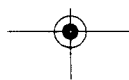

OMNI 3200 Installation Guide

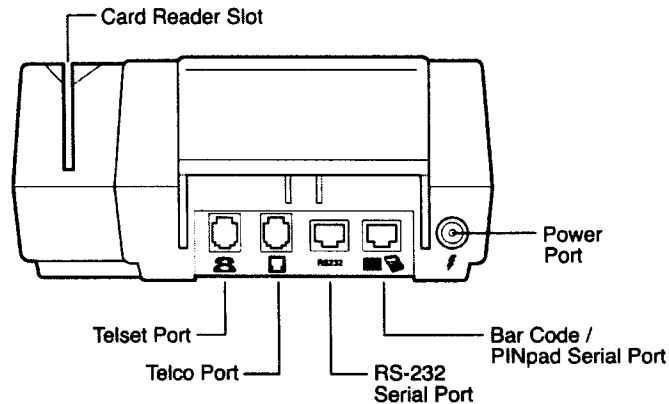

Figure 6 OMNI 3200 Connection Ports

- At the far left of the back panel are two RJ11-type modular jacks (parallel ports) for connecting the terminal to a telephone line:

The first port is identified by a telephone-shaped “Telset” icon (shown to the right). You use this Telset port to connect the OMNI 3200 to a telephone base unit.



The second telephone line port is identified by a jack-shaped “Telco” icon (shown to the right). You use this Telco port to connect the OMNI 3200 to a telephone company wall jack.



- Two RJ45-type modular jacks (serial ports) for connecting optional peripheral devices:

The first serial port is identified by an “RS232” icon (shown to the right). You use this port to connect a VeriFone CR 600 check reader, or other peripheral device.

RS232

OMNI 3200 Installation Guide

The second serial port is identified by “Bar Code and PINpad” icons (shown to the right). You use this port to connect a PINpad, smart card reader/writer, or bar code wand.



- On the lower right-hand side of the back panel, is a round port for connecting the terminal to a power source. This port is identified by an “electrical power” icon (shown to the right).



Step 4: Connect the Terminal to a Telephone Line

To process electronic transactions, the terminal automatically dials up and communicates with a host computer over a telephone line. You can connect the OMNI 3200 to a telephone line in one of two ways: with a pass-through connection or with a direct connection:

- **Pass-through connection.** The telephone line cord runs from the Telset port on the back of the terminal to a RJ11-type jack located on a standard telephone base unit.

The telephone you use for a pass-through connection must be fully functional and must have two RJ11-type modular jacks on its base: one for the direct connection of the telephone and another for the OMNI 3200 connection.

With a pass-through connection, the line is busy when the terminal is using it to dial in to a host computer, or when a host computer is dialing in to the terminal.

- **Direct connection.** The telephone line cord runs from the Telco port on the back panel of the terminal directly to a RJ11-type telephone company wall jack.

With a direct connection, the telephone line is dedicated to use by the terminal.

OMNI 3200 Installation Guide

Set Up a Pass-Through Connection

To set up a pass-through telephone line connection from the OMNI 3200 to a telephone base unit (see Figure 7):

1. Insert the connector on one end of the telephone line cord into the Telset port on the back panel of the terminal. (The Telset port is identified by the icon shown to the right.)
2. Insert the connector on the other end of the telephone line cord into the empty RJ11-type modular jack located on the telephone base unit.



Caution: If you use a pass-through connection for your terminal, do not attempt to make a normal telephone call while the terminal is processing a transaction. (If you lift up the handset, you will hear a steady, high-pitched tone.) Lifting up the handset may disrupt the carrier signal and cause transaction processing to fail.

Set Up a Direct Connection

To set up a direct telephone line connection from the OMNI 3200 terminal to a telephone company wall jack (see Figure 8):

1. Insert the connector on one end of the telephone line cord into the Telco port on the back panel of the terminal. (The Telco port is identified by the icon shown to the right.)
2. Insert the connector on the other end of the telephone line cord into a RJ11-type telephone company wall jack. (If you do not have this type of modular wall jack, you can obtain an adapter from a local business supply store.)



OMNI 3200 Installation Guide

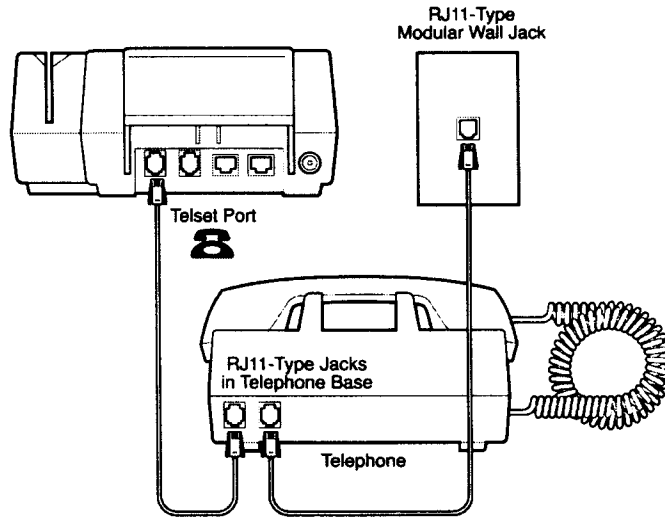

Figure 7 Pass-Through Telephone Line Connection

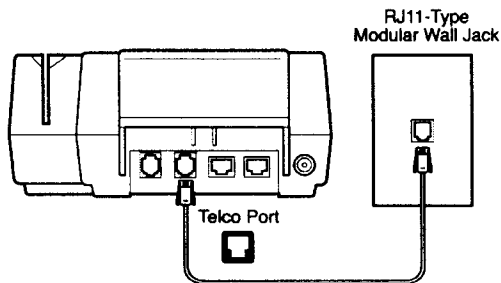

Figure 8 Direct Telephone Line Connection

OMNI 3200 Installation Guide

Step 5: Connect Optional Device(s)

The OMNI 3200 supports the complete line of VeriFone peripheral devices designed for use with Point-Of-Sale terminals. Using the two RJ45-type serial ports on the back panel of the terminal, you can connect up to two optional devices. These optional devices include various types of PINpads for entering customer PIN numbers, check readers, smart card reader/writers, and bar code wands.

Brief descriptions of how to connect various peripheral devices to the OMNI 3200 terminal are provided below. For complete information about installing and using an optional device, refer to the user documentation supplied with that device.



Warning: Before you connect a peripheral device to the OMNI 3200, be sure the terminal is not connected to a power source. If necessary, unplug the power cable from the power port on the back panel of the terminal.

Connect a PINpad

To connect a PINpad to the OMNI 3200 terminal (see Figure 9 and Figure 10):

1. If necessary, insert the small modular plug on one end of the PINpad cable into the modular jack on the PINpad.
2. If you are installing a PINpad 101, PINpad 201, or PINpad 1000, position and insert the grommet to secure the cable connection, as shown in Figure 9.
3. Insert the larger RJ45-type connector on the other end of the PINpad cable into the "Bar Code/PINpad" serial port on the back panel of the OMNI 3200 terminal.

OMNI 3200 Installation Guide

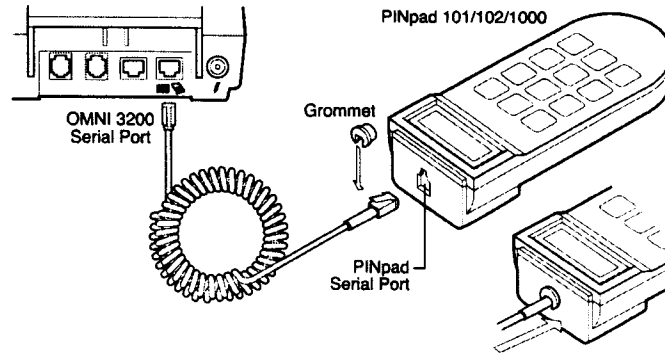

Figure 9 PINpad 101/102/1000 Connection

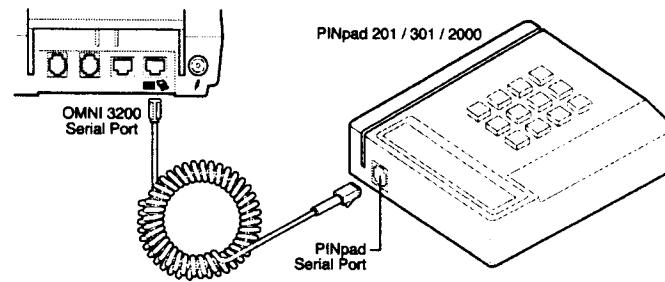

Figure 10 PINpad 201/301/2000 Connection

Connect a CR 600 Check Reader



Warning: Check readers may require a separate power source. Before you connect a check reader, or a similar device, to the OMNI 3200 terminal, be sure the device is not connected to a power source. If necessary, disconnect the power pack cable from the device.

OMNI 3200 Installation Guide

To connect a CR 600 check reader (see Figure 11):

1. If the cable is not already connected to the check reader, insert the small modular plug on one end of the cable into the modular jack on the check reader.
2. Insert the larger RJ45-type connector on the other end of the cable into the "RS232" serial port on the back panel of the OMNI 3200 terminal.

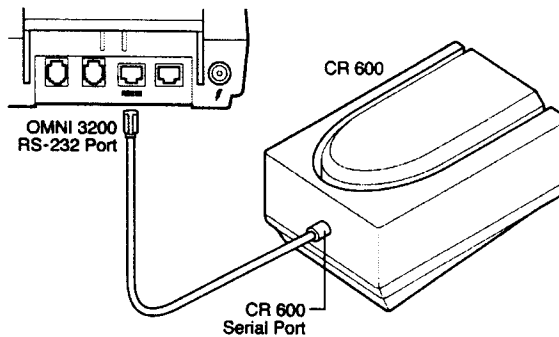

Figure 11 CR 600 Check Reader Connection

When you have completed the next step of the installation procedure, "Step 6: Connect the Terminal Power Pack," you may then connect the check reader to a power source.

Connect a Smart Card Reader/Writer or PINpad 501

To connect a SC 4xx or SC 5xx smart card reader/writer, or a PINpad 501, to the OMNI 3200 terminal (see Figure 12):

1. If a cable is not already connected to the smart card reader/writer or PINpad 501, insert the small modular plug on one end of the interface cable into the modular jack on the optional device.

OMNI 3200 Installation Guide

2. Insert the larger RJ45-type plug on the other end of the interface cable into the "Bar Code/PINpad" serial port on the back panel of the terminal.

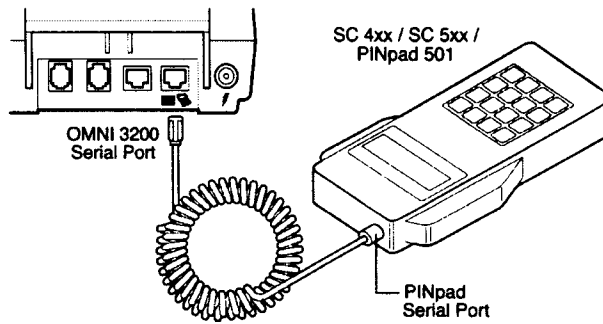

Figure 12 SC 4xx, SC 5xx, and PINpad 501 Connection

Connect a Bar Code Wand

To connect a VeriFone bar code wand, insert the RJ45-type plug on the end of the cable into the "Bar Code/PINpad" serial port on the back panel of the terminal (see Figure 13).

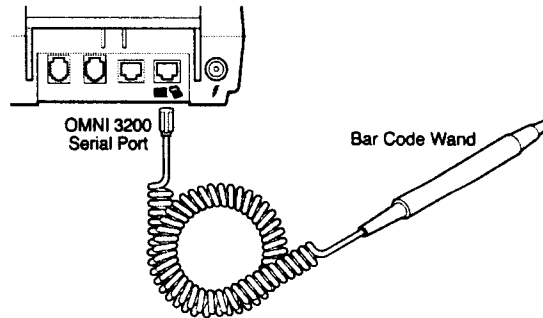

Figure 13 Bar Code Wand Connection

OMNI 3200 Installation Guide

Step 6: Connect the Terminal Power Pack



Warning: Do not plug the power pack into an outdoor outlet or operate the terminal outdoors. Also, disconnecting the power source during transaction processing may cause data files stored in the terminal memory to be lost.

To connect the OMNI 3200 terminal to a power source:

1. Insert the barrel-shaped connector on the end of one power pack cable into the round power port on the back panel of the terminal (see Figure 14). The power port is identified by the “electrical power” icon, shown to the right.
2. Plug the metal prongs on the end of the other power pack cable into an indoor electrical power outlet.

When you connect the power, the OMNI 3200 display screen, and the green LED at the top left corner of the terminal, light up. The LED should now be flashing off and on, indicating that there is no paper in the printer.

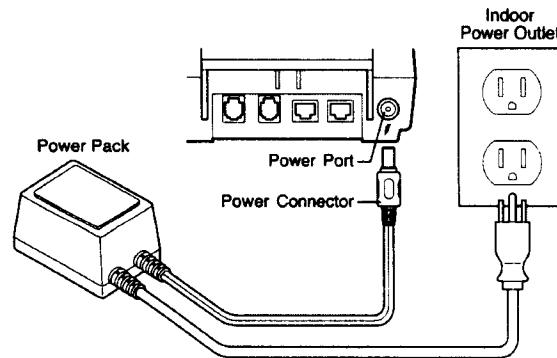

Figure 14 OMNI 3200 Power Pack Connection



OMNI 3200 Installation Guide



Step 7: Install a Paper Roll in the Printer

A fast, quiet thermal printer is built in to the OMNI 3200. Because the printer receives power directly from the terminal, there are no additional cables to connect (see Figure 15).

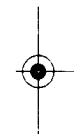
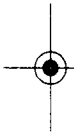
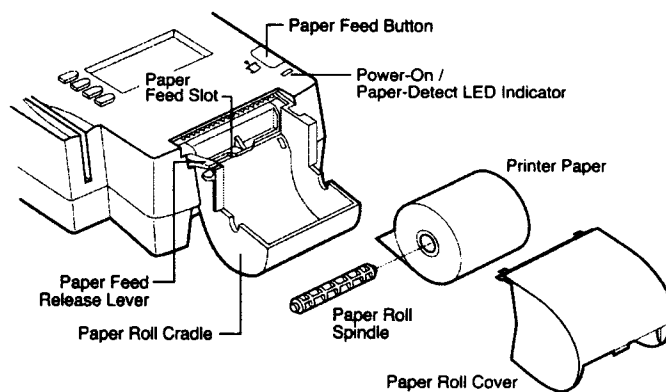

Figure 15 Thermal Printer Features

About Thermal Printer Paper

The OMNI 3200 printer uses single-ply, thermal-sensitive roll paper that is 58 millimeters (2.25 inches) wide and about 25 meters (82 feet) long. Before you can process transactions that require a receipt or record, you must install a roll of paper in the printer. This procedure is described below.



Note: You can order thermal printer paper directly from VeriFone (see "Accessories" on page 26). Because the OMNI 3200 uses standard size paper rolls, you can also purchase paper in bulk from local business supply stores.

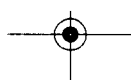

OMNI 3200 Installation Guide



Caution: Because impact, friction, temperature, humidity, light, and oil affect the coloring and storage characteristics of thermal paper, handle this type of paper carefully. Never load a roll of paper that has any folds, wrinkles, tears, or holes at edges or in the printing area. For best results, cut the leading edge of the paper, instead of tearing it, before feeding it into the printer.

Installing a Paper Roll

To install a roll of thermal printer paper in the OMNI 3200:

1. Be sure the terminal is connected to a power source. (The green LED indicator should be blinking off and on.)
2. Remove the paper roll cover from the top of the terminal by lifting up on the back of the cover.
3. Remove the protective strip from a new roll of paper and cut a clean, straight edge on the leading end of the paper.
4. Holding the roll with the paper feeding from the bottom of the roll, slowly guide the leading end into the paper feed slot (see Figure 15). When the sensor detects the paper, the feed mechanism starts automatically, advancing the paper into the printer. (If necessary, press the paper feed button until the paper emerges from the slot below the serrated metal strip.)
5. Insert the plastic spindle into the hole in the paper roll. Then, place the spindle and roll into the paper roll cradle so the ends of the spindle rest securely in the two slots.
6. If necessary, hold down the paper feed button until about 5 centimeters (2 inches) of paper emerge from the printer.
7. Replace the paper roll cover by inserting the two front tabs first and then lightly pushing down the back until it snaps in place. (Lift up the edge of the paper when you install the paper roll cover so that it rests on top of the cover.)



OMNI 3200 Installation Guide



Congratulations! Your OMNI 3200 terminal, and any optional peripheral devices you may have connected to it, should now be completely installed and ready to use.

Maintaining the OMNI 3200

Cleaning the Terminal

To remove dirt from your terminal, use a clean cloth dampened with water and mild soap. To remove stubborn stains, use alcohol or an alcohol-based cleaner.



Caution: Never use thinner, trichloroethylene, or ketone-based solvents to clean the terminal because they may cause plastic parts to deteriorate.

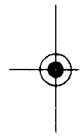

Cleaning the Printer

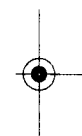

Every few months, check and thoroughly clean the printer:

1. Be sure the terminal is connected to a power source.
2. Remove the paper roll cover.
3. Remove the paper roll and spindle from the paper roll cradle, if necessary. Carefully cut the paper that is in the feed mechanism from the roll.
4. Press the paper feed button to remove the remaining paper from the feed mechanism.



Caution: Do not attempt to pull paper out from the back of the printer. This could damage the paper feed mechanism.

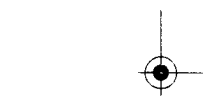
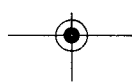
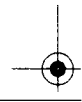

OMNI 3200 Installation Guide

5. Remove any dirt, dust, or scraps of paper that may be adhering to, or lodged in, the printer parts.
6. Re-install the paper roll, or a new roll, as described in "Installing a Paper Roll" on page 17.
7. Check the paper roll cover for signs of damage, wear, or warping.
8. Press the paper feed button to advance the paper through the slot below the serrated metal strip and replace the paper roll cover.

Returning a Terminal for Service



Note: Unless otherwise instructed in this Installation Guide, do not, under any circumstances, attempt any service, adjustments, or repairs on this product. Instead, contact VeriFone. Service conducted by parties other than VeriFone may invalidate our warranty.

Before returning a terminal, you must obtain a Merchandise Return Authorization (MRA) number. The following procedures tells you how to return one or more terminals for repair or replacement:

1. Before you contact VeriFone, please gather the following information:
 - Model(s) to be returned. A model and part number are located on the bottom of each terminal. For example, OMNI 3200 and P092-xxx-xx (see Figure 16).
 - Serial number(s) of the terminal(s) to be returned. A serial number (S/N xxx-xxx-xxx) is located on the bottom of each terminal, just above the bar code (see Figure 16).

OMNI 3200 Installation Guide

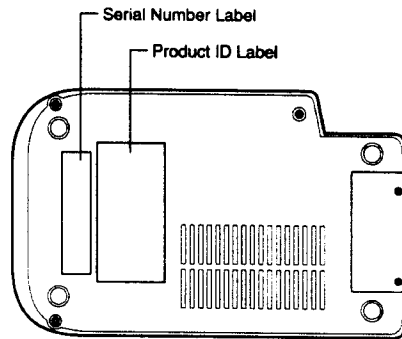

Figure 16 Product Information on Bottom of Terminal

- Brief description of the problem(s).
 - Your billing address.
 - Your shipping address. This is where the repaired or replacement unit(s) will be returned.
2. From inside the United States, call 800-834-9133. From outside the United States, call 502-425-1332 (in the U.S.).
 3. Select the MRA option from the automated message. The MRA Department is open from 7 a.m. to 5 p.m. Pacific Standard Time.
 4. Give the MRA representative the information you gathered in Step 1.
 5. If the list of serial numbers is long, you can fax the list, along with the information gathered in Step 1, to the MRA Department. Include a telephone number where you can be reached and your fax number. Please print clearly and send your fax to the attention of the "VeriFone MRA Dept." at 502-329-5947 or 502-329-5938. (These fax numbers are in the U.S.). You will be issued an MRA number and the fax will be returned to you.

OMNI 3200 Installation Guide

6. Please note that one MRA number must be issued for each terminal you return to VeriFone, even if you are returning several terminals of the same model (OMNI 3200).
7. Be sure to record and keep:
 - MRA number(s)
 - Serial numbers of all the terminals your are returning
 - Shipping documentation (such as airbill numbers)

Troubleshooting

During normal, day-to-day operation of your OMNI 3200 terminal, it is possible that minor malfunctions may occur. Here are some examples of possible problems, and steps you can take to resolve them.

Terminal Display Does Not Show Correct or Readable Information

1. Check all cable connections and verify that the telephone line is properly connected.
2. Check the electrical outlet. The power pack connectors may be loose or the outlet may not be supplying power.
3. Replace the power pack that came with your terminal with a power pack from another OMNI 3200 terminal. If this solves the problem, contact VeriFone to obtain a replacement power pack.
4. If the problem persists, contact VeriFone.

Telephone Connection Does Not Work Properly

1. Check the telephone line cord and all telephone connections.



OMNI 3200 Installation Guide



2. If you are using a pass-through connection, check the line using another telephone base unit. If the other telephone works, have the defective telephone repaired or replaced.
3. If you are using a direct connection, check the telephone line using another OMNI 3200 terminal. If the telephone connection does not work, contact your local telephone company to check the status of the line.

Printer Does Not Work

1. Check all terminal power connections. The integrated printer receives its power directly from the OMNI 3200 terminal. The LED indicator light in the upper left corner of the terminal should be on.
2. If the LED indicator is blinking off and on, the printer is out of paper. Remove the paper roll cover and install a new roll of printer paper.
3. If the problem persists, contact VeriFone.

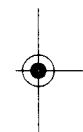
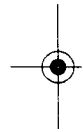

Printer Paper is Jammed-in the Feed Mechanism

1. Remove the paper roll cover. Then, lift up on the small lever located on right side of the paper roll cradle until it snaps into its "up" position (see Figure 15). This lets you move the paper freely through the paper feed mechanism.
2. Carefully cut the damaged paper from the paper roll and clear the remaining paper from the feed mechanism.
3. Lower the paper release lever until it snaps back into its default ("down") position.
4. Re-install the roll of printer paper. If the problem persists, install a new roll of higher-quality paper.

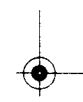
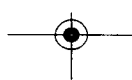
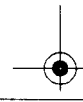



OMNI 3200 Installation Guide



PINpad Does Not Work

1. Check all PINpad cable connections.
2. Try a different magnetic stripe card to ensure that the problem is not a defective card.
3. If the problem persists, contact VeriFone.

Serial Port Does Not Work

1. The two serial ports on the back panel of the terminal are identified by the "RS232" and "Bar Code/PINpad" icons. Check that the device connected to the serial port is functioning correctly. If possible, perform a self-test on the device in question.
2. The cable connecting the optional device to the OMNI 3200 serial port may be defective. Try using a different serial cable, if possible.
3. If the problem persists, contact VeriFone.

Terminal Transactions Do Not Work

The cause of the problem may be the card reader:

1. Perform transactions with several cards to ensure the problem is not a defective card.
2. Make sure you are swiping cards properly. With the OMNI 3200 card reader, the black, magnetic stripe on the card should face downward and to the right.

The cause of the problem may be a terminal hardware or software malfunction:

1. Process a transaction manually using the keypad instead of the card reader.

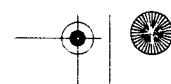
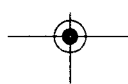
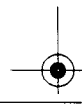
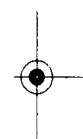
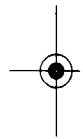



OMNI 3200 Installation Guide



2. If the manual transaction works, contact VeriFone to have your terminal repaired or replaced.
3. If the manual transaction does not work, check the telephone line using another telephone base unit or another OMNI 3200 terminal.

The cause of the problem may be the telephone line of the party the terminal is dialing up, or your own telephone line:

1. If the problem appears to be with the telephone line, check with the party you are trying to call to see if their system is operational. If they are not experiencing difficulties with their line, contact the telephone company to have your line checked.
2. If the telephone line works, contact VeriFone to return your terminal for service.

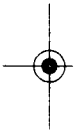

Keypad Does Not Respond

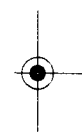

1. Check the display panel. If it displays the wrong character, or nothing at all, when you press a key, please follow the steps outlined above in "Terminal Display Does Not Show Correct or Readable Information."
2. If pressing a function key does not perform the expected action, refer to the user documentation for your specific application to be sure you are entering data correctly.
3. If the problem persists, contact VeriFone.

Optional Bar Code Wand Does Not Work

1. Check all bar code wand cable connections.
2. Draw the wand across a different bar code to ensure that the problem is not an unreadable bar code.

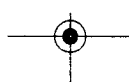



OMNI 3200 Installation Guide



Calling the VeriFone Customer Support Hot Line

If you cannot resolve a problem you are experiencing with your OMNI 3200 terminal using these troubleshooting tips, or if a VeriFone representative is not readily available to assist you, call the VeriFone Customer Support Hot Line for assistance:

- From inside the U.S., call 800-654-1674 (toll-free)
- Outside the U.S., call 502-425-1332 (in the U.S.)

Specifications

Power

- Terminal power requirements:
 - 120 V AC at 60 Hz (U.S.)
 - 100–250 V AC at 50–60 Hz (International)
- Power pack requirements:
 - AC power pack: 22 V AC at 2 A (U.S.)
 - DC power pack: 25.5 V DC at 1.57 A (International)

Environmental

- Operating temperature: 0° to 40° C (32° to 104° F)
- Storage temperature: – 18° to + 66° C (0° to 150° F)
- Humidity: 15% to 95% relative humidity; no condensation

Dimensions

- Height: 75 mm (2.95 inches)
- Width: 146 mm (5.75 inches)
- Depth: 290 mm (11.4 inches)

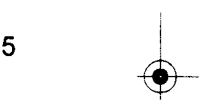
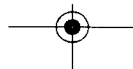
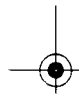
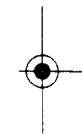
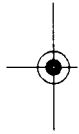



OMNI 3200 Installation Guide



Weight

- Terminal unit weight: 1050 g (2.3 lb)
- Shipping weight: 2750 g (6.1 lb); includes terminal, power pack, telephone line cable, paper roll, and plastic spindle

Accessories

How to Order

Ordering VeriFone accessories and consumable supplies is easier than ever. The VeriFone Online Store, on the Internet at www.store.verifone.com, provides easy access and secure ordering for products and accessories, as well as up-to-the-minute information about other VeriFone countertop systems.

From inside the United States, you can also call in your accessories order to the VeriFone Customer Development Center at 1-800-233-0522. If you are located outside the United States, contact your local VeriFone representative.

Accessories and documentation you can order for the OMNI 3200 are listed below. When ordering, please refer to the part number in the left column.

Download Cables

05651-xx	MOD10-MOD10 (terminal-to-terminal download cables)
26263-xx	02xxx MOD10-PC DB25F (terminal-to-PC download cables)
26264-xx	02xxx MOD10-PC DE9F (terminal-to-PC download cables)

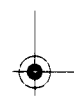
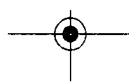
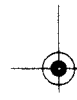

OMNI 3200 Installation Guide

Cables for Optional Peripherals

- 07041-xx MOD10-MDIN9 (for CR 600 check reader)
07042-xx MOD10-4P4C (for all VeriFone PINpads)

Telephone Line Cord

- 00124-03 2.1-meter (7-foot) telephone line cord, silver color, with modular RJ11-type connectors

Power Pack

- 07096-01G AC power pack (U.S.)
05790-xx DC power pack (International)

Thermal Printer Paper

- CRM0039 High-grade thermal printer paper, 58-mm (2.25-inch) width; single roll
CRM0039-01 High-grade thermal printer paper, 58-mm (2.25-inch) width; 30-roll bulk package

Paper Roll Spindle

- 02117-03 Plastic spindle for 58-mm (2.25-inch) rolls of thermal printer paper

Documentation

- 05996 *OMNI 3200 Installation Guide*
19134 *OMNI 3200 Reference Manual*
19135 *OMNI 3200 Programmer's Manual*



4988 Great America Parkway
Santa Clara, CA 95054-1200
Telephone: 408-496-0444
Fax: 408-919-1405
Internet: www.verifone.com

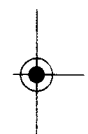
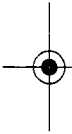

OMNI 3200

Installation Guide

VeriFone Part Number 05996, Revision A

